

SIZES AVAILABLE				
Product Code	Width	Height	Length	Weight
SC0585-0710	28"/0.710m	23"/0.585m	96"/2.440m	1.220T
SC1150-1100	43"/1.100m	45"/1.150m	96"/2.440m	2.600T
SC1150-1530	60"/1.530m	45"/1.150m	96"/2.440m	2.570T
SC1150-1830	72"/1.830m	45"/1.150m	79"/2.000m	2.420T
SC1150-2000	79"/2.000m	45"/1.150m	79"/2.000m	2.550T
SC1150-2440	96"/2.440m	45"/1.150m	79"/2.000m	2.250T
SC1650-1100	43"/1.100m	65"/1.650m	79"/2.000m	2.630T
SC1650-1500	59"/1.500m	65"/1.650m	79"/2.000m	3.047T
SC1650-1830	72"/1.830m	65"/1.650m	79"/2.000m	3.156T

These robust precast reinforced concrete slurry channels are designed to BS5502 part 22 & BSEN1992 Part 1.

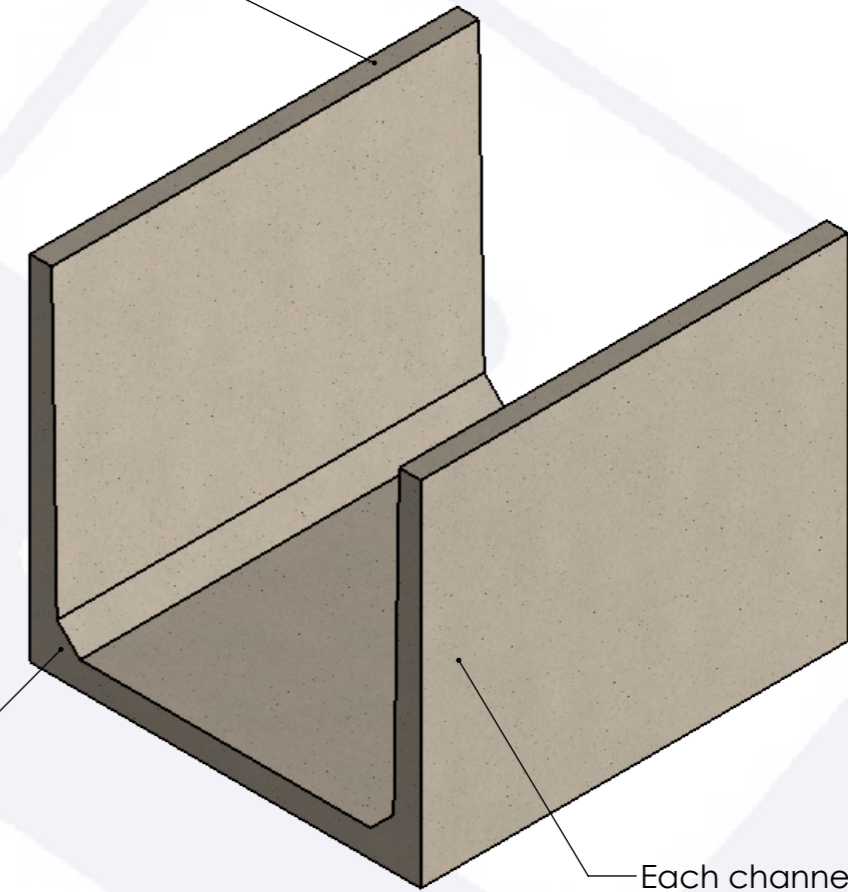

End units, tees and corner units are available for all sizes of channel, we are also able to provide solid concrete (or galvanised steel) covers and slats to suit the channels.

Each channel unit is cast with two lifting sockets in the top for easy lifting and fitting, they can be quickly laid on to a compact hard-core bed, blinded with sand or semi dry concrete.

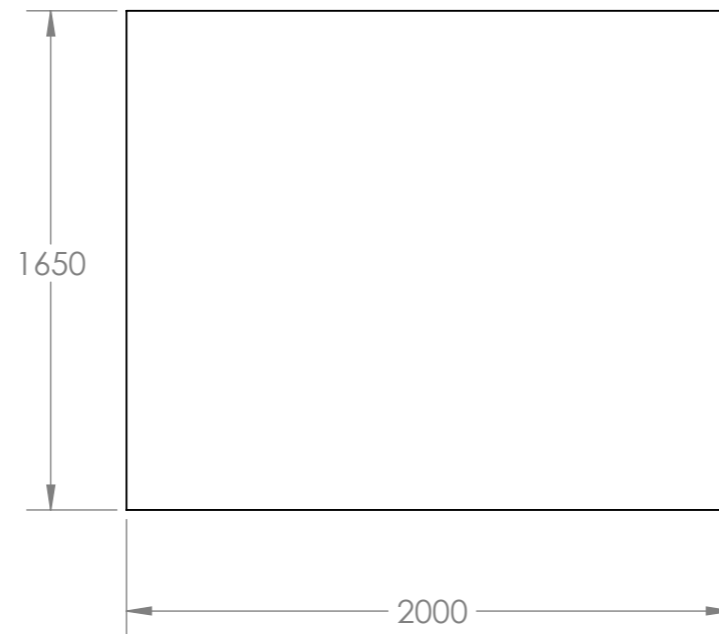
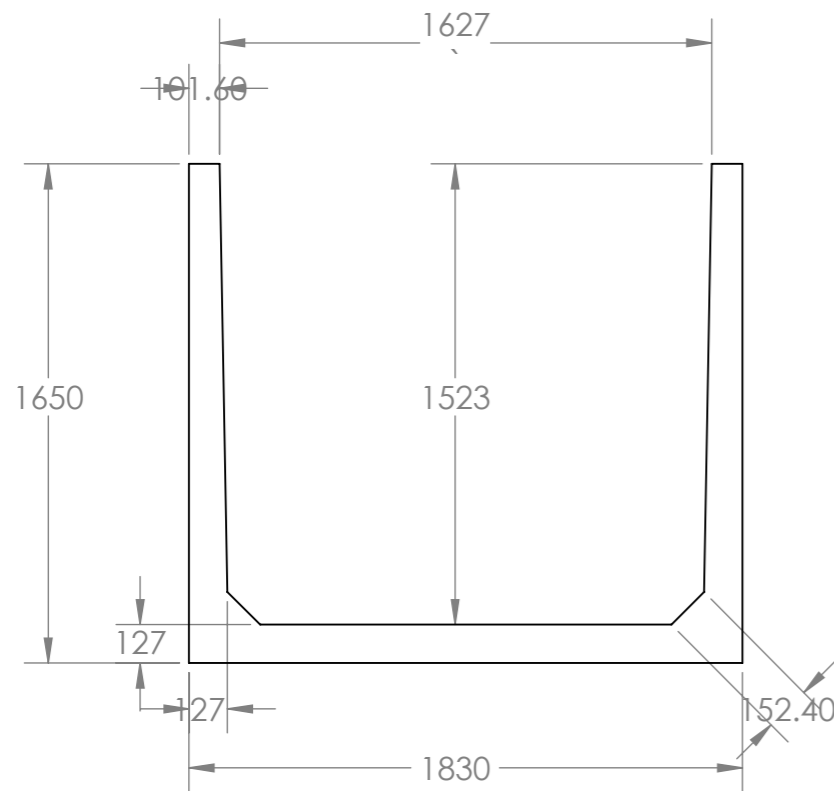

DO NOT SCALE DRAWING		REVISION	
			
CRAVEN CONCRETE LTD Manufacture, Supply & Installation of Quality Concrete For Agriculture And Industry WWW.CRAVENCONCRETE.CO.UK			
TITLE: 72" X 65" SLURRY CHANNEL			
DWG NO. SC1650-1830		MATERIAL: CONCRETE	
NAME	SIGNATURE	DATE	WEIGHT: 3.156T
DRAWN SAM KIRBY		29/03/18	TOLERANCES: +/-5mm
CHK'D			A3 SCALE:1:25 SHEET 1 OF 1